

Towbar



Ford

• Fiësta (ST-Line)

2008->

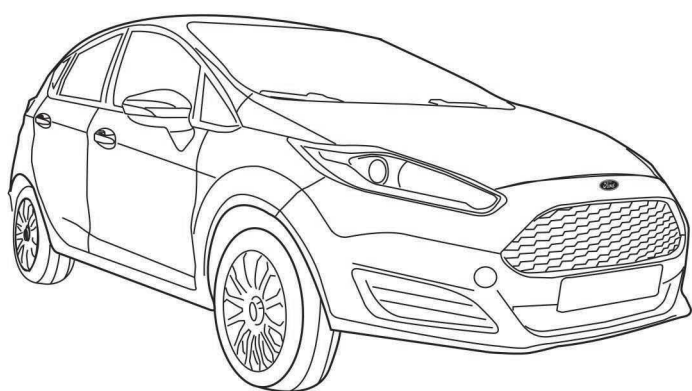

- NL Montagehandleiding
- GB Fitting instructions
- D Montageanleitung
- F Instructions de montage
- S Monteringsanvisningar
- DK Montagevejledning
- E Instrucciones de montaje
- I Istruzioni per il montaggio
- PL Instrukcja monta¿u
- SF Asennusohjeet
- CZ Pokyny k montá¿i
- H Szerelési útmutató
- RUS Руководство для монтажа

BRiNK[®]

Your perfect fit
brink.eu

Couplingsclass: A50-X

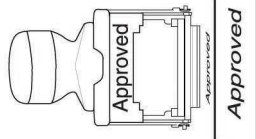

ECER55

E11 55R 0110915

Max. vertical load : 50 kg

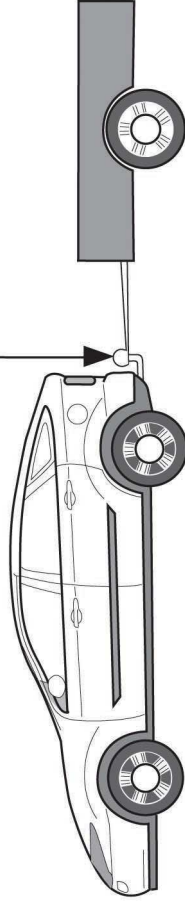

D-Value: 5,7 kN

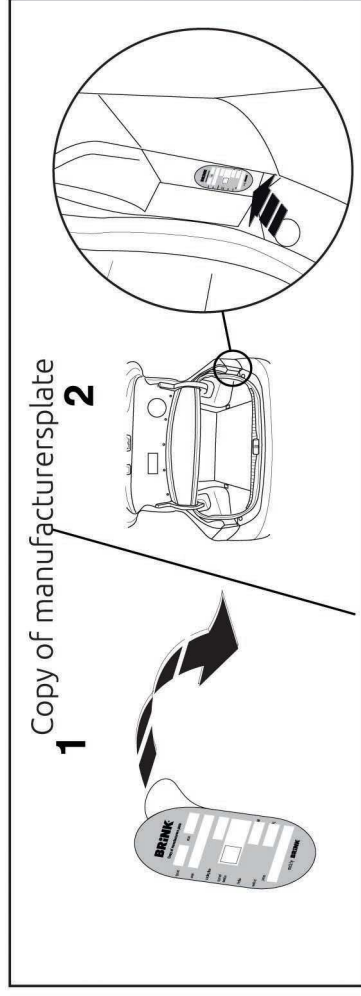
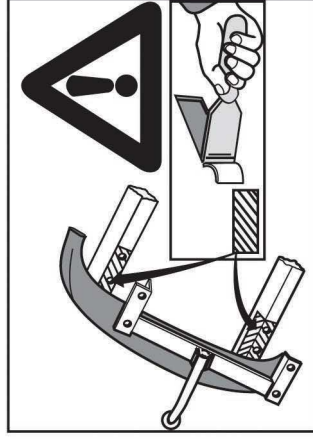
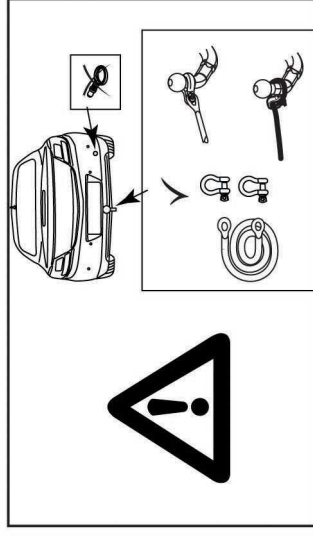
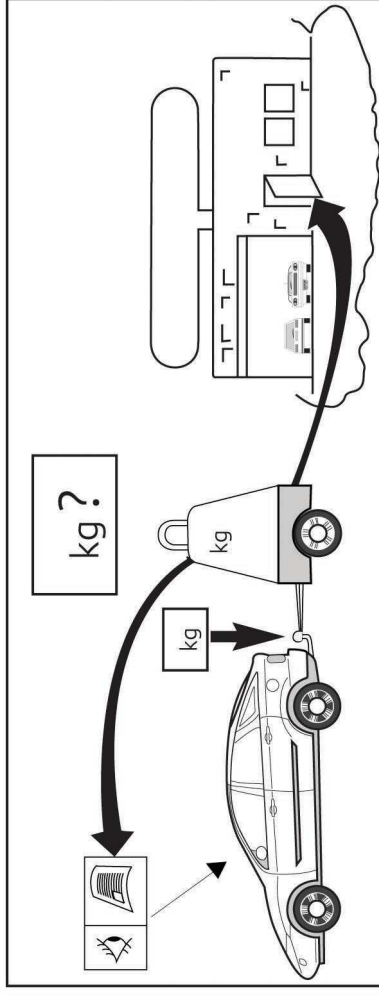
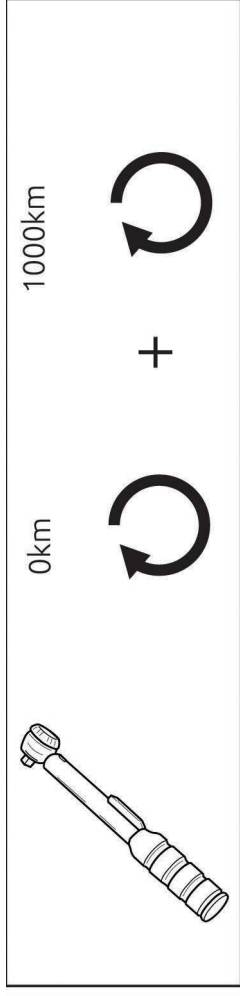
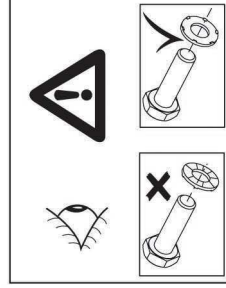
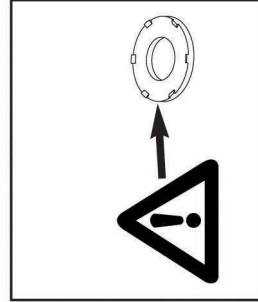
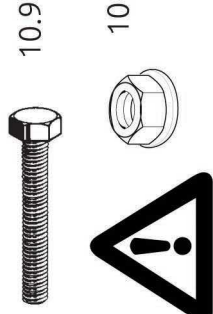

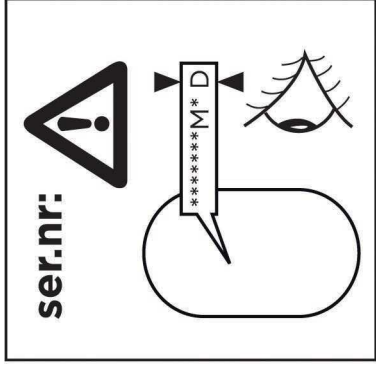
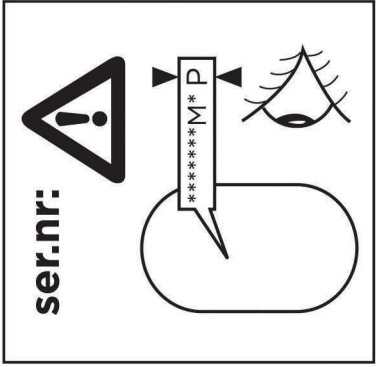
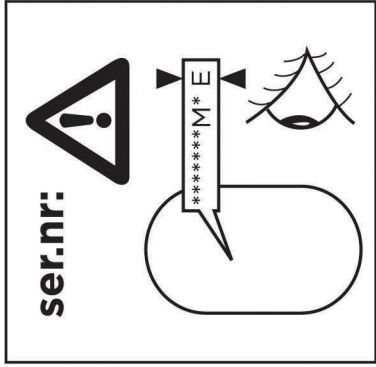
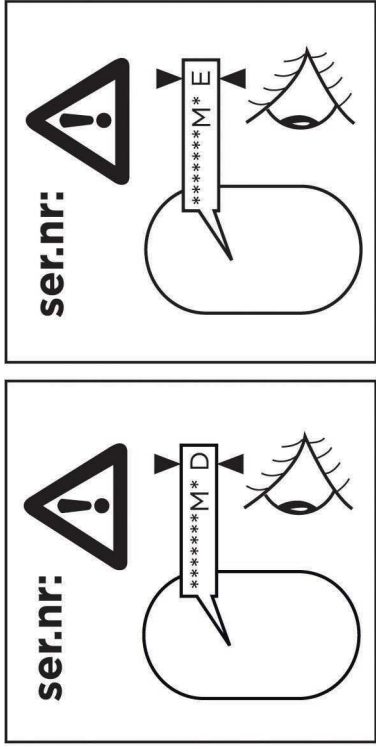

628680

M10x35 (10.9)
45Nm

M10x35 (10.9)
45Nm

6286/2

M6x20 (10.9)
15Nm

9550017

M12x20 (100)
130Nm

6286/3

9550017

9520095

M12x25 (100)
130Nm

9555845

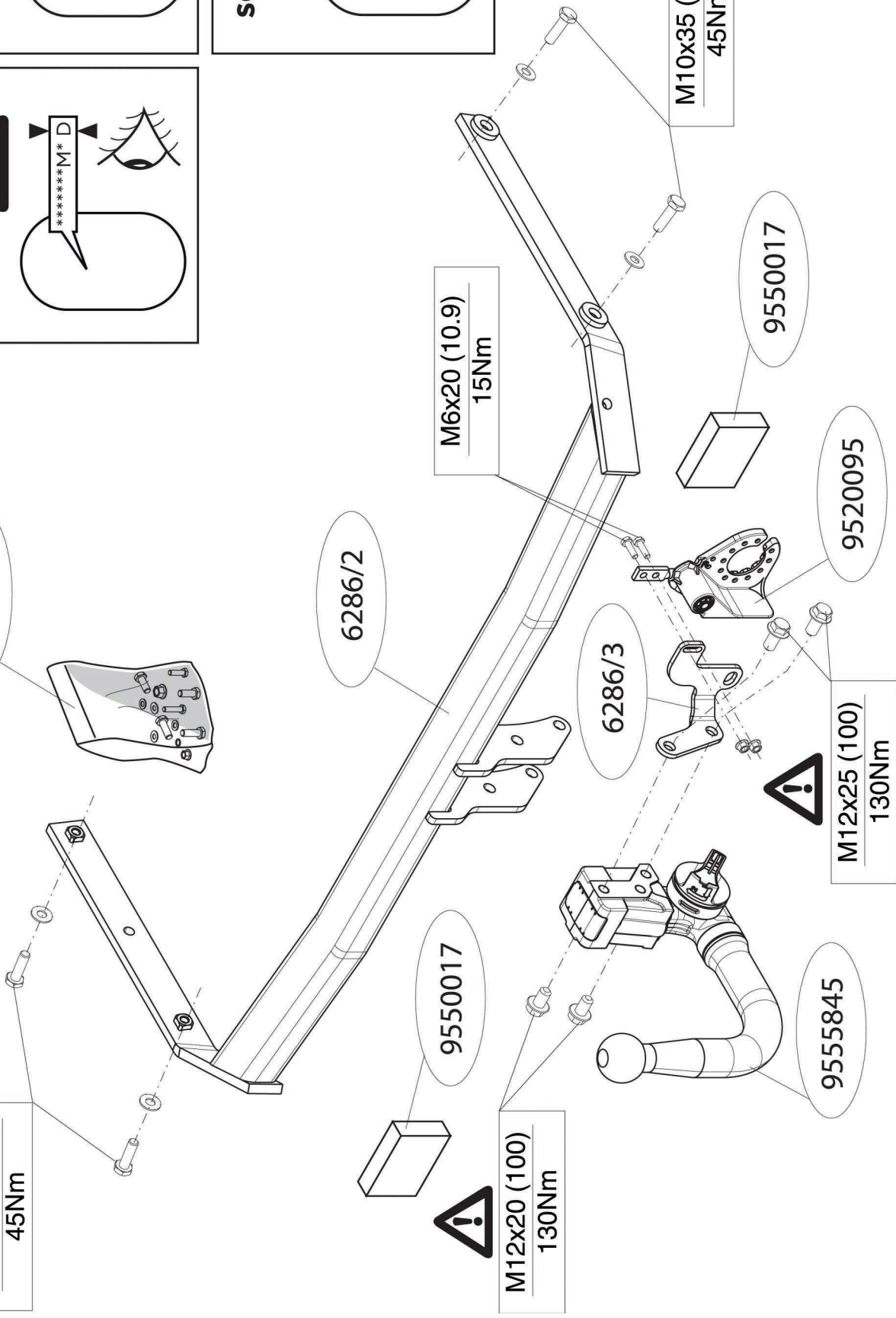

INSTRUCTIONS DE MONTAGE:

Avant de commencer le montage veuillez vérifier la plaque signalétique de l'attelage afin de déterminer la figure correspondante dans la notice de montage.

1. Déposer le pare-chocs ainsi que le polystyrène expansé. Voir la figure 1.
2. Monter l'attache-remorque dans le châssis.
3. Placer les deux blocs de mousse en polyester en guise de colmatage dans les longerons de châssis.
4. Scier au centre de la partie inférieure du pare-chocs une partie correspondant à la figure 2.
5. Mettre en place le pare-chocs.
6. Monter le Brink Connector et compris la prise rabattable avec collier (6286/3).
7. Serrer tous les boulons et écrous conformément au schéma.

Pour le montage et le démontage des pièces du véhicule, consulter la notice du fabricant.

Consulter le croquis pour voir le montage et les moyens de fixation.













Pour le montage et le démontage de la rotule amovible, consulter la notice de montage jointe.

REMARQUE:













- * Pour une/des adaptations indispensables sur le véhicule, veuillez consulter le concessionnaire.
- * Enlever la couche de bitume ou d'anti-tremblement qui recouvre éventuellement les points de fixation.
- * Pour connaître le poids de traction maximum et le poids en flèche sur la rotule autorisée du véhicule, veuillez consulter votre concessionnaire.
- * **Veiller en perçant à ne pas endommager les conduites de électrique, de frein et de carburant.**
- * Retirer "si présents" les embouts en plastique des écrous de soudure par point.

* Cette notice de montage doit être conervée à bord du véhicule après montage de l'attelage.

* Brink Towing Systems B.V. décline toute responsabilité pour les dommages qui pourraient directement ou indirectement résulter d'un montage incorrect, y compris l'utilisation d'outils inappropriés et l'utilisation d'un mode d'emploi et de moyens autres que ceux prescrits, ou bien résulter d'une interprétation inexacte des présentes instructions de montage.

-  Lokatie/Positie pijl
-  Location/Position Arrow
-  Positionspfeil
-  Flèche de Position
-  Positionpil
-  Lokaliseringsspil
-  Flecha de posición
-  Freccia di posizione
-  Strzałka położenia
-  Paikannusnuoli
-  Šipka na pozíci
-  Helyzetjelző nyíl
-  Локация / Место встречи

-  NL
-  GB
-  D
-  F
-  S
-  DK
-  E
-  I
-  PL
-  SF
-  CZ
-  H
-  RUS

-  Richtingspijl
-  Movement Arrow
-  Bewegungspfeil
-  Flèche de mouvement
-  Rörelsepil
-  Bevægelsespil
-  Flecha de movimiento
-  Freccia di movimento
-  Strzałka kierunku ruchu
-  Liikesuuntanuoli
-  Šipka pohybu
-  Mozgásirányjelzőnyíl
-  Стрелка движения

-  NL
-  GB
-  D
-  F
-  S
-  DK
-  E
-  I
-  PL
-  SF
-  CZ
-  H
-  RUS

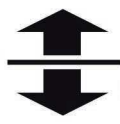
 2x

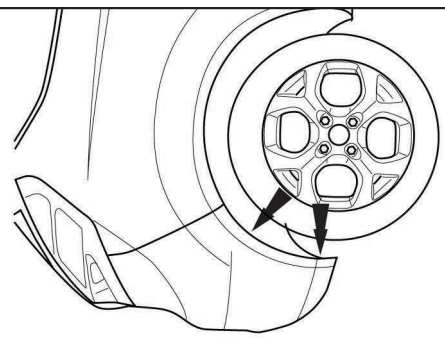
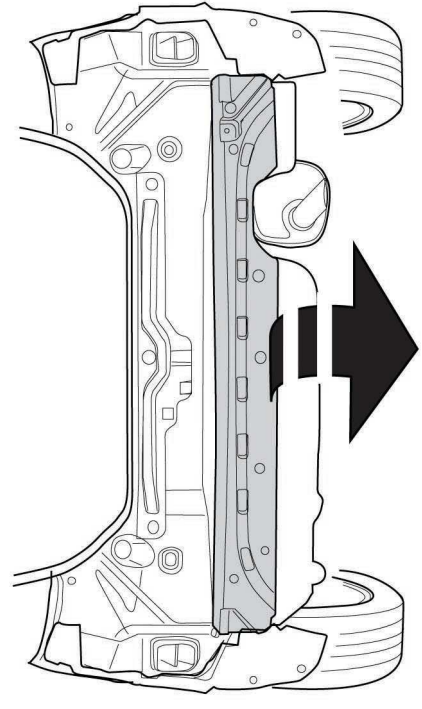
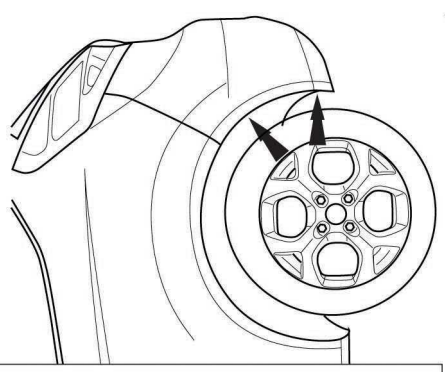
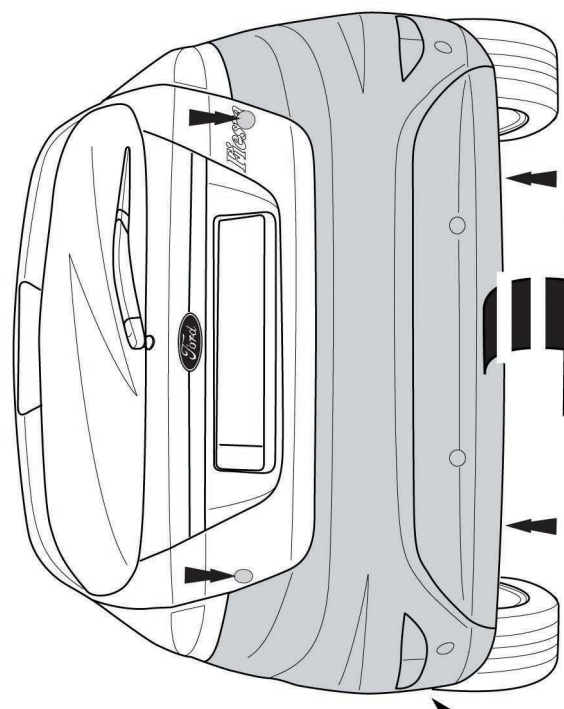

Fig.1

ST-Line

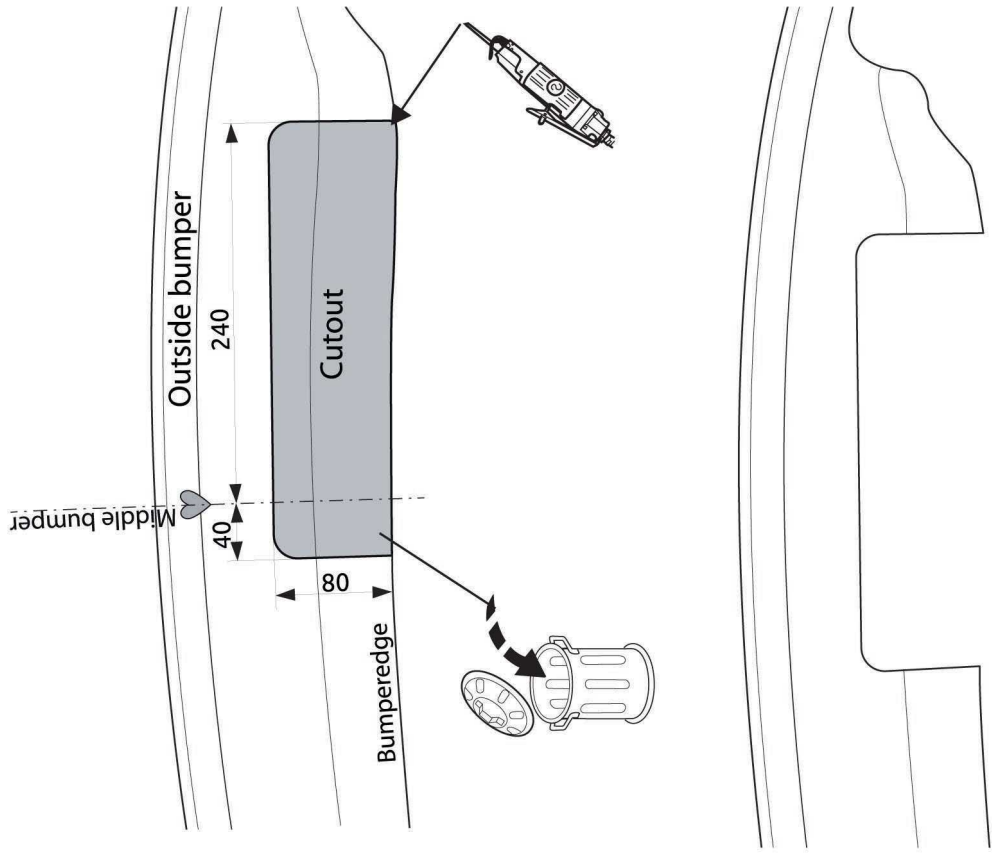
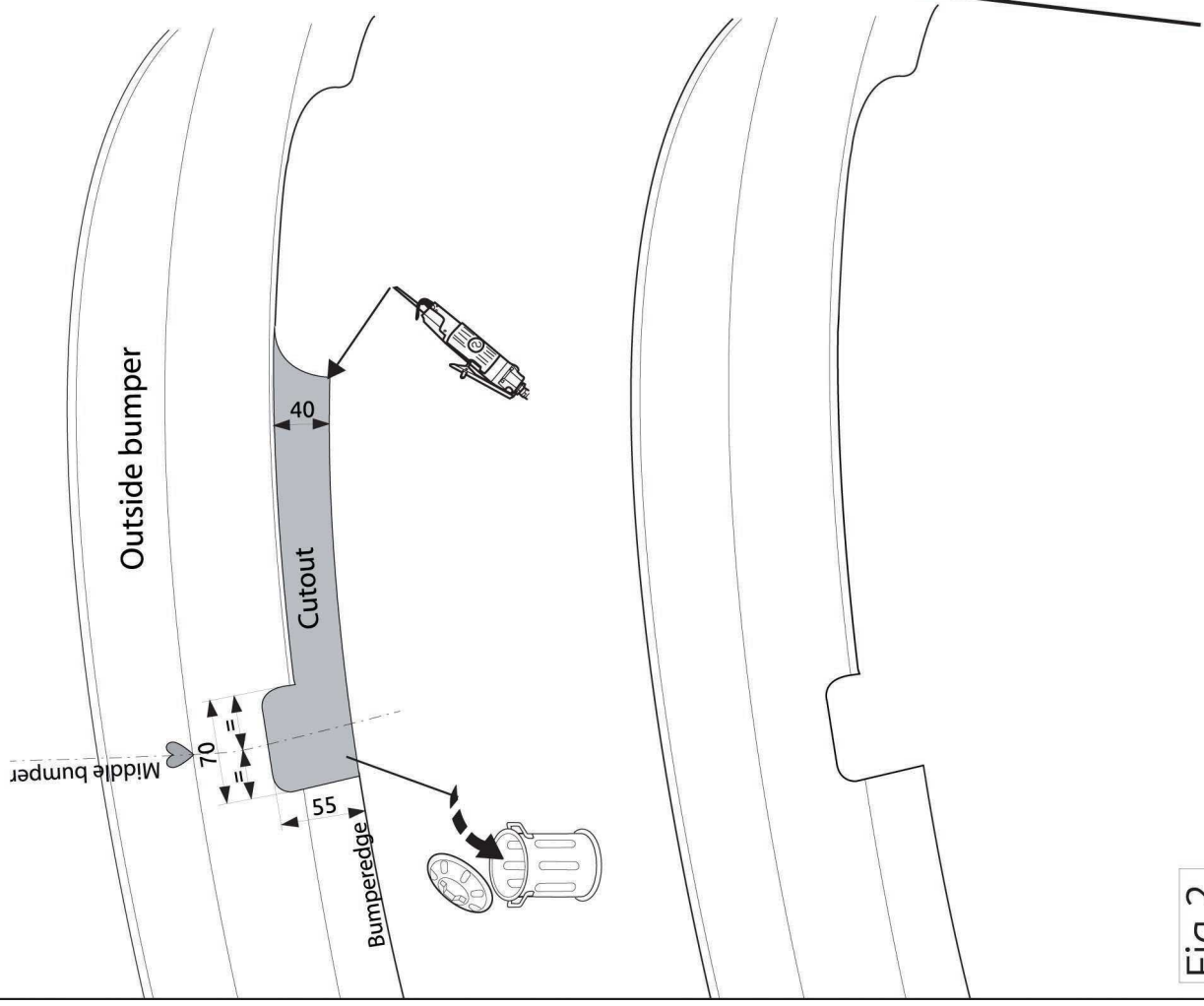

Fig.2